

**Фитинг прямой PC**

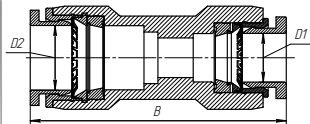

Модель	D, мм	G, дюйм	A, мм	B, мм	L, мм	H, мм	C
PC06-G01	6	1/8	5	19.9	6.7	12	5/32"
PC06-G02		1/4	5.8	20.4	6.4		
PC06-G03		3/8	6.8	20	4.5		
PC06-G04							
PC08-G01	8	1/8	5	24.4	11.1	14	3/16"
PC08-G02		1/4	5.8	22.2	7		7/32"
PC08-G03		3/8	5.8	21.2	4.5		
PC08-G04							
PC10-G01	10	1/8	5	26.3	11	17	5 мм
PC10-G02		1/4	5.8	27.5	13.9		6 мм
PC10-G03		3/8	6.8	25	8.9		5/16"
PC10-G04		1/2	8	22.7	4.9		
PC12-G02	12	1/4	5.8	31.2	12	20	6 мм
PC12-G03		3/8	6.8	28.2	11		5/16"
PC12-G04		1/2	8	28.9	9.5		6 мм
PC14-G04							
PC16-G03							
PC16-G04							

**Фитинг угловой PL**

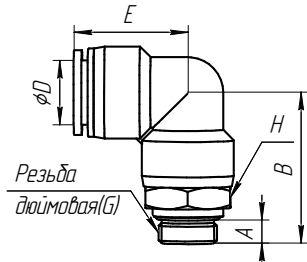

Модель	D, мм	G, дюйм	A, мм	B, мм	E, мм	H, мм
PL04-G01	4	1/8	5	24	17.5	14
PL04-G02		1/4	5.8	25.3		17
PL06-G01	6	1/8	5	25.5	19	14
PL06-G02		1/4	5.8	26.5		17
PL06-G03		3/8	6.8	28		20
PL06-G04						
PL08-G01	8	1/8	5	28.5	22.8	14
PL08-G02		1/4	5.8	29.8		17
PL08-G03		3/8	6.8	31.3		20
PL08-G04		1/2	8	32.5		24
PL10-G01	10	1/8	5	33.3	26.3	17
PL10-G02		1/4	5.8	34.1		20
PL10-G03		3/8	6.8	35.6		24
PL10-G04		1/2	8	37.8		
PL12-G02	12	1/4	5.8	36.8	29.6	21
PL12-G03		3/8	6.8	37.8		
PL12-G04		1/2	8	39.5		
PL14-G03	14					
PL14-G04						
PL16-G03	16					
PL16-G04						

**Дроссель NSE**

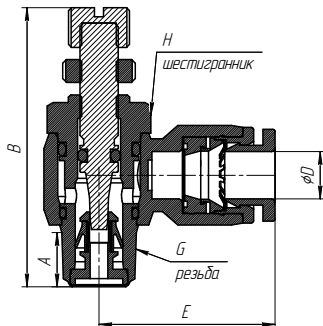

Модель	D, мм	G, дюйм	A, мм	H, мм	E, мм	B(max), мм
NSE04-G01	4	1/8	5.8	10	22.3	39.7
NSE04-G02		1/4	7.3	14	24.1	46.4
NSE06-G01	6	1/8	5.8	10	23.1	39.7
NSE06-G02		1/4	7.3	14	25.1	46.4
NSE06-G03		3/8	8.5	19	26.8	53.4
NSE08-G01	8	1/8	5.8	10	25.6	39.7
NSE08-G02		1/4	7.3	14	28.6	46.4
NSE08-G03		3/8	8.5	19	29.6	53.4
NSE08-G04		1/2	10	24	32.6	57.9
NSE10-G02	10	1/4	7.3	14	31.1	46.4
NSE10-G03		3/8	8.5	19	31.6	53.4
NSE10-G04		1/2	10	24	34.6	57.9
NSE12-G02	12	1/4	7.3	14	33.5	46.4
NSE12-G03		3/8	8.5	19	35.6	53.4
NSE12-G04		1/2	10	24	36.6	57.9

**Заглушки**

**IBP**

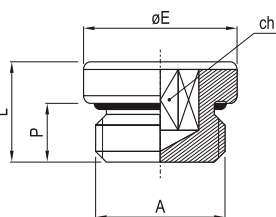

Модель	A	P	L	E	ch
IBP-M5	M5	4.5	7.2	8	2.5
IBP-01	G1/8	6.5	9.5	14	5
IBP-02	G1/4	8	11.5	17	6
IBP-03	G3/8	9	12.5	20	8
IBP-04	G1/2	10	14	26	10

**IBP-G**

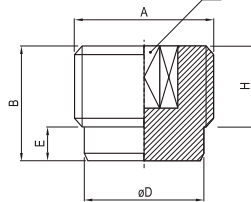
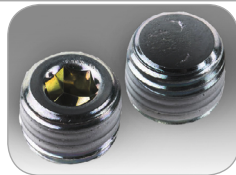

Модель	A	B	D	E	H	ch
IBP-01	G1/8	8	7.5	2	6	5
IBP-02	G1/4	10	10	3.5	8.5	6

**BSL**

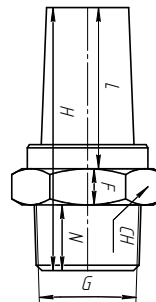
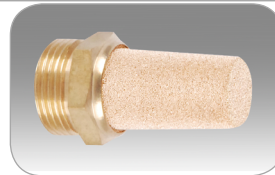

Модель	G	CH	F	H	L	N	Модель	G	CH	F	L	N
BSL-M5	M5	8	5	19	12	3	BSLM-M5	M5	8	5	9.5	3
BSL-01	G1/8	12	6	24	14	4	BSLM-01	G1/8	12	6	12	4
BSL-02	G1/4	16	8	30	18	4	BSLM-02	G1/4	17	8	15	4
BSL-03	G3/8	18	9	35	21	5	BSLM-03	G3/8	19	9	17	5
BSL-04	G1/2	24	10	44	28	6	BSLM-04	G1/2	24	10	18.5	6
BSL-06	G3/4	30	10	50	32	8	BSLM-06	G3/4	30	10	21	8

**Глушители**

**BSLM**

